

## Operating Instructions Air Conditioner



### Model No.

#### Indoor Unit

CS-TE20TKEW  
CS-TE25TKEW  
CS-TE35TKEW  
CS-TE42TKEW  
CS-TE50TKEW  
CS-TE60TKEW  
CS-TZ20TKEW  
CS-TZ25TKEW  
CS-TZ35TKEW  
CS-TZ42TKEW  
CS-TZ50TKEW  
CS-TZ60TKEW  
CS-TZ71TKEW  
CS-MTZ16TKE

#### Outdoor Unit

##### Single Split (R410A)

CU-TE20TKE  
CU-TE25TKE  
CU-TE35TKE  
CU-TE42TKE  
CU-TE50TKE  
CU-TE60TKE

##### Single Split (R32)

CU-TZ20TKE  
CU-TZ25TKE  
CU-TZ35TKE  
CU-TZ42TKE  
CU-TZ50TKE  
CU-TZ60TKE  
CU-TZ71TKE

#### Outdoor Unit

##### Multi Split (R410A)

CU-3E18PBE  
CU-4E23PBE  
CU-5E34PBE  
CU-2E12SBE  
CU-2E15SBE  
CU-2E18SBE  
CU-3E23SBE  
CU-2RE15SBE  
CU-2RE18SBE  
CU-3RE18SBE

##### Multi Split (R32)

CU-2Z35TBE  
CU-2Z41TBE  
CU-2Z50TBE  
CU-3Z52TBE  
CU-3Z68TBE  
CU-4Z68TBE  
CU-4Z80TBE  
CU-5Z90TBE  
CU-2TZ41TBE  
CU-2TZ50TBE  
CU-3TZ52TBE

### Operating Instructions Air Conditioner

2-15

Before operating the unit, please read these operating instructions thoroughly and keep them for future reference. The included Installation Instructions should be kept and read by the installer before installation. Remote control is packaged in the indoor unit and removed by the installer before installation.

### Comment utiliser l'appareil Climatiseur

16-29

Avant d'utiliser l'appareil, veuillez lire ce mode d'emploi dans son intégralité et conservez-le pour toute référence ultérieure. Le manuel d'installation inclus doit être conservé et lu par l'installateur avant l'installation. La télécommande est emballée dans l'unité intérieure et retirée par l'installateur avant l'installation.

### Instrucciones de funcionamiento Climatizador de aire

30-43

Antes de utilizar la unidad, sírvase leer atentamente estas instrucciones de funcionamiento y conservarlas para futuras consultas. El instalador debe guardar y leer las Instrucciones de instalación incluidas antes de la instalación. El mando a distancia viene embalado en la unidad interior y debe ser retirado por el instalador antes de la instalación.

### Bedienungsanleitung Klimagerät

44-57

Bevor Sie das Gerät in Betrieb nehmen, lesen Sie bitte diese Bedienungsanleitung aufmerksam durch und bewahren Sie sie als künftige Referenz auf. Das mitgelieferte Installationshandbuch sollte aufbewahrt und vor der Installation vom Installateur gelesen werden. Die Fernbedienung ist im Innengerät verpackt und wird vor der Installation durch den Installateur entfernt.

### Istruzioni di funzionamento Condizionatore d'aria

58-71

Prima di utilizzare l'unità, leggere attentamente le istruzioni e conservare questo opuscolo per potervi fare riferimento in futuro. Le istruzioni per l'installazione fornite in dotazione devono essere conservate e lette dall'installatore prima dell'installazione. Il telecomando si trova nell'unità interna e deve essere rimosso dall'installatore prima dell'installazione.

### Handleiding Airconditioner

72-85

Lees voor u het apparaat gebruikt deze gebruikshandleiding grondig en bewaar deze voor toekomstig gebruik. De bijgevoegde installatiehandleiding moet door de installateur worden bewaard en gelezen vóór de installatie. De afstandsbediening is in de binneneenheid verpakt en moet vóór de installatie door de installateur worden verwijderd.

English

Français

Español

Deutsch

Italiano

Nederlands



ACXF55-04100

Provides maximum comfort and clean air with optimal energy saving methods.

## Multi air conditioner system

Multi air conditioner systems save space by letting you connect multiple indoor units to a single outdoor unit. For complete product features, please refer catalogue.

Use remote control within 8 m from the remote control receiver of the indoor unit.

\* Remote control display and functions may vary depending on the model.

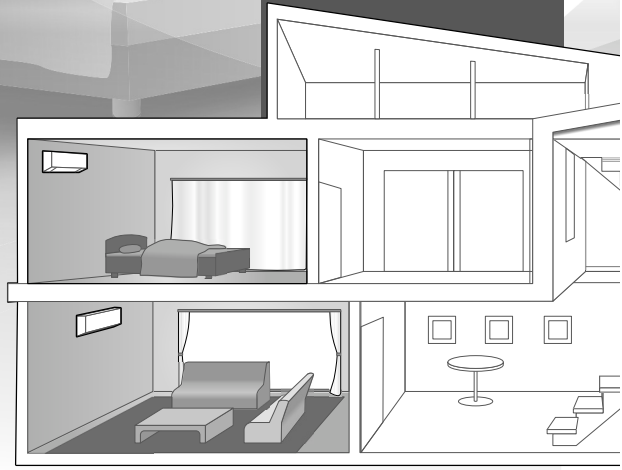

## Quick Guide

### Inserting the batteries

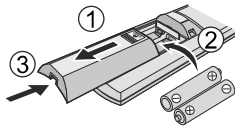

- ① Pull out the back cover of remote control.
- ② Insert AAA or R03 batteries.
- ③ Close the cover.

### Ⓐ Clock setting



- ① Press **CLOCK** and set the time **▲▼**.
- Press **CLOCK** and hold for approximately 5 seconds to show time in 12-hour (am/pm) or 24 hour indication.
- ② Confirm **SET**.

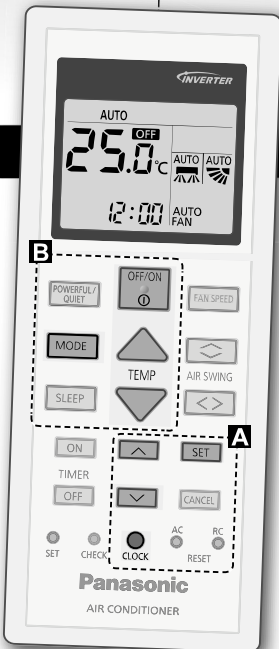

Thank you for purchasing  
Panasonic Air Conditioner.

## Table of contents

Safety precautions..... 4-7  
 How to use..... 8-9  
 To learn more..... 10-11  
 Cleaning instructions..... 12  
 Troubleshooting..... 13-15  
 Information..... 86

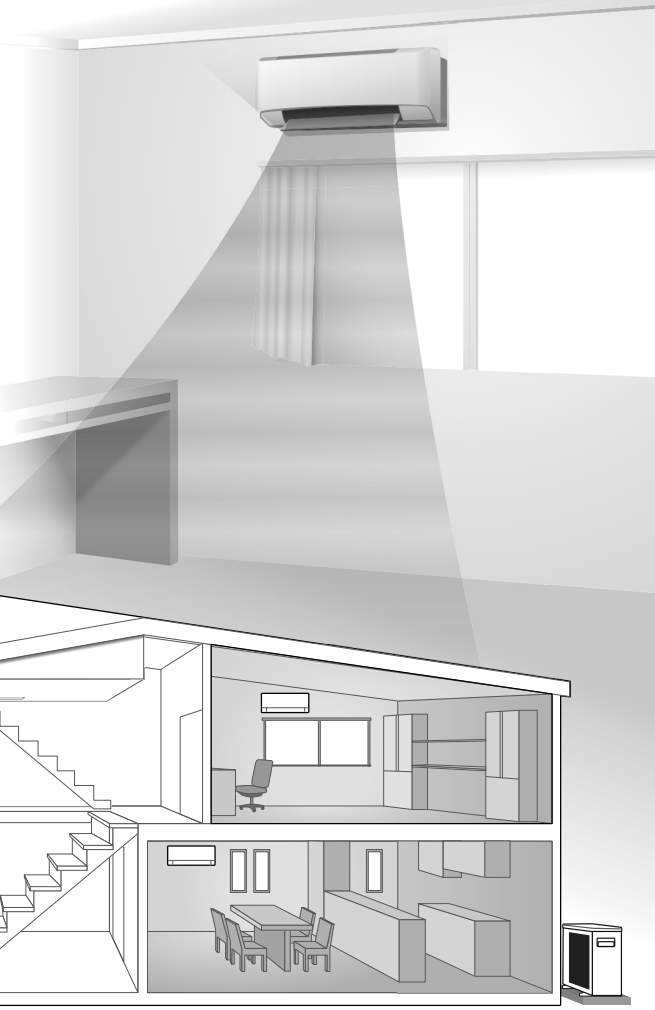

### Accessories

- Remote control
- AAA or R03 batteries × 2
- Remote control holder
- Screws for remote control holder × 2

The illustrations in this manual are for explanation purposes only and may differ from the actual unit. They are subject to change without notice for future improvement.

## B Basic operation

① Press **MODE** to select the desired mode.

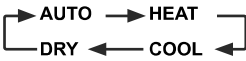

② Press **OFF/ON** to start/stop the operation.

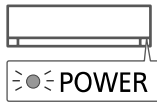

• Please note that the **OFF** indication is on display to start the unit.

③ Select the desired temperature.

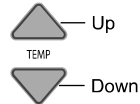

Selection range:  
16.0 °C ~ 30.0 °C /  
60 °F ~ 86 °F.

• Press and hold **TEMP** for approximately 10 seconds to switch the temperature indication in °C or °F.

# Safety precautions

To prevent personal injury, injury to others or property damage, please comply with the following:  
 Incorrect operation due to failure to follow instructions below may cause harm or damage, the seriousness of which is classified as below:  
 This appliance is not intended for accessibility by the general public.

 **For appliance filled with R32 (mild flammable refrigerant).** If the refrigerant is leaked and exposed to an external ignition source, there is a risk of fire.

 **WARNING** This sign warns of death or serious injury.

 **CAUTION** This sign warns of injury or damage to property.

The instructions to be followed are classified by the following symbols:

 This symbol denotes an action that is PROHIBITED.

    These symbols denote actions COMPULSORY.

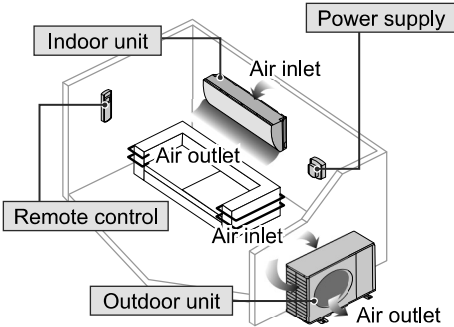

## **WARNING**

### Indoor unit and outdoor unit

 This appliance can be used by children aged from 8 years and above and persons with reduced physical, sensory or mental capabilities or lack of experience and knowledge if they have been given supervision or instruction concerning use of the appliance in a safe way and understand the hazards involved.  
 Children shall not play with the appliance. Cleaning and user maintenance shall not be made by children without supervision.

Please consult authorised dealer or specialist to clean the internal parts, repair, install, remove and reinstall the unit. Improper installation and handling will cause leakage, electric shock or fire.

Confirm with authorised dealer or specialist on usage of any specified refrigerant type. Using refrigerant type other than the specified may cause product damage, burst and injury etc.

 Do not install the unit in a potentially explosive or flammable atmosphere. Failure to do so could result in fire.

Do not insert your fingers or other objects into the air conditioner indoor or outdoor unit, rotating parts may cause injury. 

Do not touch the outdoor unit during lightning, it may cause electric shock.

 Do not expose yourself directly to cold air for a long period to avoid excess cooling.

Do not sit or step on the unit, you may fall down accidentally.



## Remote control

 Do not allow infants and small children to play with the remote control to prevent them from accidentally swallowing the batteries.

## Power supply

 Do not use a modified cord, joint cord, extension cord or unspecified cord to prevent overheating and fire.



To prevent overheating, fire or electric shock:

- Do not share the same power outlet with other equipment.
- Do not operate with wet hands.
- Do not over bend the power supply cord.
- Do not operate or stop the unit by inserting or pulling out the power plug.



If the supply cord is damaged, it must be replaced by the manufacturer, service agent or similarly qualified persons in order to avoid a hazard.

It is strongly recommended to be installed with Earth Leakage Circuit Breaker (ELCB) or Residual Current Device (RCD) to prevent electric shock or fire.

To prevent overheating, fire or electric shock:

- Insert the power plug properly.
- Dust on the power plug should be periodically wiped with a dry cloth.

Stop using the product if any abnormality/failure occurs and disconnect the power plug or turn off the power switch and breaker.  
(Risk of smoke/fire/electric shock)

Examples of abnormality/failure

- The ELCB trips frequently.
  - Burning smell is observed.
  - Abnormal noise or vibration of the unit is observed.
  - Water leaks from the indoor unit.
  - Power cord or plug becomes abnormally hot.
  - Fan speed cannot be controlled.
  - The unit stops running immediately even if it is switched on for operation.
  - The fan does not stop even if the operation is stopped.
- Contact your local dealer immediately for maintenance/repair.



This equipment must be earthed to prevent electrical shock or fire.



Prevent electric shock by switching off the power supply and unplug:



- Before cleaning or servicing,
- When extended non-use, or
- During abnormally strong lightning activity.

# Safety precautions



## WARNING

### Precaution for appliance filled with R32

Pay careful attention to the following points when operating the appliances and dealing with different refrigerants.



The appliance shall be installed, and/or operated in a room with floor area larger than  $A_{min}$  (m<sup>2</sup>) and keep away from ignition sources, such as heat/sparks/ open flame or hazardous areas such as gas appliances, gas cooking, reticulated gas supply systems or electric cooking appliances, etc. (Refer to Table A of Installation instructions table for  $A_{min}$  (m<sup>2</sup>))

Be aware that refrigerant may not contain an odour, highly recommended to ensure suitable flammable refrigerant gas detectors are present, operating and able to warn of a leak.

Since the working pressure is higher than that of refrigerant R22 models, some of the piping and installation and service tools are special.

Especially, when replacing a refrigerant R22 model with a new refrigerant R32 model, always replace the conventional piping and flare nuts with the R32 and R410A piping and flare nuts on the outdoor unit side.

The R32 flare nut and pipe on the outdoor unit side can also be used for a R410A model.



Models that use refrigerant R32 and R410A have a different charging port thread diameter to prevent erroneous charging with refrigerant R22 and for safety. Therefore, check beforehand. [The charging port thread diameter for R32 and R410A is 12.7 mm (1/2 inch).]

Be extra careful so that foreign matter (oil, water, etc.) does not enter the piping.

Also, when storing the piping, securely seal the opening by pinching, taping, etc. (Handling of R32 is similar to R410A.)

This appliance shall be stored in a well ventilated area.

This appliance shall be stored in a room without continuously operating open flames and ignition sources.

This appliance shall be stored so as to prevent mechanical damage from occurring.



Do not use means to accelerate the defrosting process or to clean, other than those recommended by manufacturer. Any unfit method or using incompatible material may cause product damage, burst and serious injury.

Do not pierce or burn as the appliance is pressurized. Do not expose the appliance to heat, flame, sparks, or other sources of ignition. Else it may explode and cause injury or death.



## CAUTION

### Indoor unit and outdoor unit



Do not wash the indoor unit with water, benzine, thinner or scouring powder to avoid damage or corrosion at the unit.

Do not use for preservation of precise equipment, food, animals, plants, artwork or other objects. This may cause quality deterioration, etc.

Do not use any combustible equipment in front of the airflow outlet to avoid fire propagation.

Do not expose plants or pet directly to airflow to avoid injury, etc.

Do not touch the sharp aluminium fin, sharp parts



Do not switch ON the indoor unit when waxing the floor. After waxing, aerate the room properly before operating the unit.

Do not install the unit in oily and smoky areas to prevent damage to the unit.

Do not dismantle the unit for cleaning purpose to avoid injury.

Do not step onto an unstable bench when cleaning the unit to avoid injury.

Do not place a vase or water container on the unit. Water may enter the unit and degrade the insulation. This may cause an electric shock.

Do not open window or door for long time during operation, it may lead to inefficient power usage and uncomfortable temperature changes.



Prevent water leakage by ensuring drainage pipe is:  
-Connected properly,  
-Kept clear of gutters and containers, or  
-Not immersed in water

After a long period of use or use with any combustible equipment, aerate the room regularly.

After a long period of use, make sure the installation rack does not deteriorate to prevent the unit from falling down.

### Remote control



Do not use rechargeable (Ni-Cd) batteries. It may damage the remote control.



To prevent malfunction or damage of the remote control:  
•Remove the batteries if the unit is not going to be used for a long period of time.  
•New batteries of the same type must be inserted following the polarity stated.

### Power supply



Do not disconnect the plug by pulling the cord to prevent electric shock.

# How to use



Indicator

- POWER (Green)
- TIMER (Orange)

## CS-TE/TZ20/25/35/42TKEW CS-MTZ16TKE



## CS-TE50/60TKEW CS-TZ50/60/71TKEW

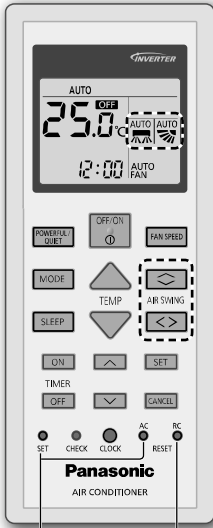

Not used in normal operations.

Press to restore the remote control to default setting.

### To adjust airflow direction

(CS-TE/TZ20/25/35/42TKEW, CS-MTZ16TKE)



- Do not adjust the flap by hand.

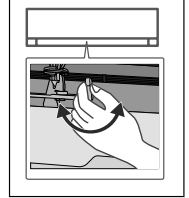

- For lateral direction, it is manually adjustable as shown.

### To adjust airflow direction

(CS-TE50/60TKEW, CS-TZ50/60/71TKEW)

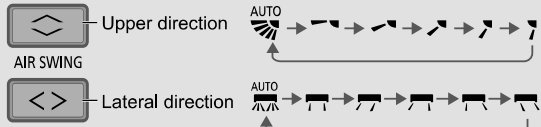

- Do not adjust the flap by hand.

### To adjust fan speed



- For AUTO, the indoor fan speed is automatically adjusted according to the operation mode.
- To have low noise priority operation, select the lowest fan speed (■).

### To switch between powerful/quiet

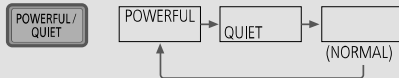

#### POWERFUL:

To reach the preset temperature quickly

- This operation stops automatically after 20 minutes.

#### QUIET:

To enjoy quiet operation

- This operation reduces airflow noise.



## To maximise comfort while sleeping

This operation provides you with a comfortable environment while sleeping. It will automatically adjust the sleep pattern temperature during the activation period. The indoor unit indicator will dim when this operation is activated. This is not applicable if the indicator brightness has been manually dimmed.

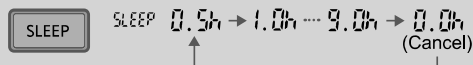

This operation is incorporated with the activation timer (0.5, 1, 2, 3, 4, 5, 6, 7, 8 or 9 hours).

- This operation can be set together with timer. Sleep operation has the priority over OFF timer.
- This operation can be cancelled by pressing the respective button when the sleep timer reaches 0.0h.

## To set the timer

2 sets of ON and OFF timers are available to turn ON or OFF the unit at different preset times.

The diagram illustrates the steps to set the timer:

- 1 Select ON or OFF timer**  
Each time pressed:  $\text{ON} \rightarrow \text{OFF} \rightarrow \text{Cancel}$
- 2 Set the time**  
Example: OFF at 22:00
- 3 Confirm**

The diagram shows the remote control buttons and the display screen. The display shows the timer setting (OFF @1) and the time (22:00).

- To cancel ON or OFF timer, press **ON** or **OFF** to select respective  $\text{O}1$  or  $\text{O}2$  then press **CANCEL**.
- If timer is cancelled manually or due to power failure, you can restore the timer again by pressing **ON** or **OFF** to select respective  $\text{O}1$  or  $\text{O}2$  then press **SET**.
- The nearest timer setting will be displayed and will activate in sequence.
- Timer operation is based on the clock set in the remote control and repeats daily once set. For clock setting, please refer to Quick Guide.

## Note

<ul style="list-style-type: none"> <li>• Can be activated in all modes and can be cancelled by pressing the respective button again.</li> </ul>	<ul style="list-style-type: none"> <li>• Cannot be selected at the same time.</li> </ul>
---	--

# To learn more...

## Operation mode

**AUTO** : During operation, the POWER indicator will blink at initial.

**Single**

- Unit selects operation mode every 10 minutes according to the setting and room temperatures.

**Multi**

- Unit selects operation mode every 3 hours according to setting temperature, outdoor temperature and room temperature.
- It is possible to operate the indoor units individually or simultaneously. The priority of operation is placed on the first unit that turned on.
- During operation, HEAT and COOL modes cannot activate at the same time for different indoor units.
- The power indicator blinks to indicate the indoor unit is standing by for different operation mode.

**HEAT** : The POWER indicator blinks at the initial stage of this operation. Unit takes a while to warm up.

**Multi**

- For system which HEAT mode has been locked, if operation mode other than HEAT is selected, the indoor unit stops and the POWER indicator blinks.

**COOL** : Provides efficient comfort cooling to suit your needs.

**DRY** : Unit operates at low fan speed to give a gentle cooling operation.

## Energy saving temperature setting

Operating the unit within the recommended temperature range may save energy.

**HEAT** : 20.0 °C ~ 24.0 °C / 68 °F ~ 75 °F.

**COOL** : 26.0 °C ~ 28.0 °C / 79 °F ~ 82 °F.

## Air flow direction

**In COOL/DRY mode:**

(CS-TE/TZ20/25/35/42TKEW, CS-MTZ16TKE)

If AUTO is set, the flap swings up/down automatically.

(CS-TE50/60TKEW, CS-TZ50/60/71TKEW)

If AUTO is set, the flap swings left/right and up/down automatically.

**In HEAT mode:**

If AUTO is set, the horizontal flap is fixed at the predetermined position. The vertical flap swings left/right after the temperature rises.

## Auto restart control

If power is resumed after a power failure, the operation will restart automatically after a period of time with previous operation mode and airflow direction.

- This control is not applicable when TIMER is set.

## Operating conditions

Use this air conditioner in the temperature range indicated in the table.

Temperature °C (°F)		Indoor		Single split outdoor unit *1		Multi split outdoor unit *2	
		DBT	WBT	DBT	WBT	DBT	WBT
COOL	Max.	32 (89.6)	23 (73.4)	43 (109.4)	26 (78.8)	46 (114.8)	26 (78.8)
	Min.	16 (60.8)	11 (51.8)	-10 (14.0)	-	-10 (14.0)	-
HEAT	Max.	30 (86.0)	-	24 (75.2)	18 (64.4)	24 (75.2)	18 (64.4)
	Min.	16 (60.8)	-	-15 (5.0)	-16 (3.2)	-15 (5.0)	-16 (3.2)

Temperature °C (°F)		Multi split outdoor unit *3	
		DBT	WBT
COOL	Max.	43 (109.4)	26 (78.8)
	Min.	16 (60.8)	11 (51.8)
HEAT	Max.	24 (75.2)	18 (64.4)
	Min.	-10 (14.0)	-11 (12.2)

DBT: Dry bulb temperature, WBT: Wet bulb temperature

\*1 CU-TE20TKE, CU-TE25TKE, CU-TE35TKE, CU-TE42TKE, CU-TE50TKE, CU-TE60TKE, CU-TZ20TKE, CU-TZ25TKE, CU-TZ35TKE, CU-TZ42TKE, CU-TZ50TKE, CU-TZ60TKE, CU-TZ71TKE

\*2 CU-3E18PBE, CU-4E23PBE, CU-4E27PBE, CU-5E34PBE, CU-2E12SBE, CU-2E15SBE, CU-2E18SBE, CU-3E23SBE, CU-2Z35TBE, CU-2Z41TBE, CU-2Z50TBE, CU-3Z52TBE, CU-3Z68TBE, CU-4Z80TBE, CU-5Z90TBE

\*3 CU-2RE15SBE, CU-2RE18SBE, CU-3RE18SBE, CU-2TZ41TBE, CU-2TZ50TBE, CU-3TZ52TBE

# Cleaning instructions

To ensure optimal performance of the unit, cleaning has to be carried out at regular intervals. Dirty unit may cause malfunction and you may see error code "H 99". Please consult authorised dealer.

- Switch off the power supply and unplug before cleaning.
- Do not touch the aluminium fin, sharp parts may cause injury.
- Do not use benzine, thinner or scouring powder.
- Use only soap (≈ pH 7) or neutral household detergent.
- Do not use water hotter than 40 °C / 104 °F.

## Indoor unit

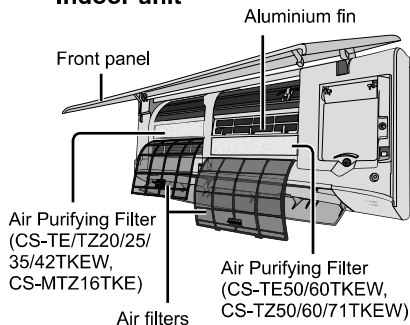

### Indoor unit

Wipe the unit gently with a soft, dry cloth.

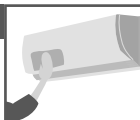

### Outdoor unit

Make sure the air outlet of the outdoor unit is not blocked by fallen leaves or snow. Clear any blockage from the drain pipe.

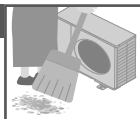

### Air Purifying Filter

- Do not wash/rinse the filter with water.
- Replace the filter every 2 years or replace any damaged filter. Part no.: CZ-SA31P

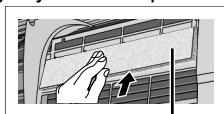

Air Purifying Filter

### Air filters

Once every 2 weeks

- Wash/rinse the filters gently with water to avoid damage to the filter surface.
- Dry the filters thoroughly under shade, away from fire or direct sunlight.
- Replace any damaged filters.



### Remove air filter

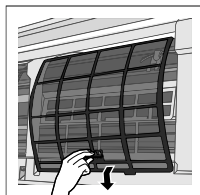

### Attach air filter

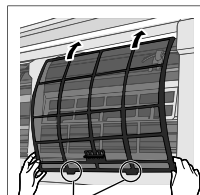

Insert into the unit

### Front panel

Wash gently and dry.

#### Remove the front panel

- ② Pull out and lift up.

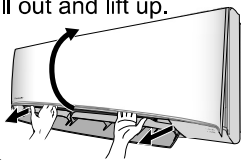

- ① Release the hooks at both ends.

#### Close it securely

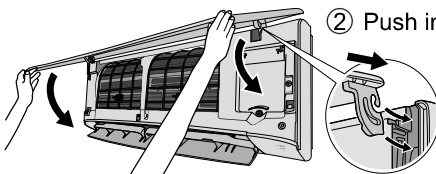

- ③ Close down.
- ④ Press both ends and center of the front panel.

- ② Push in.

- ① Insert at both sides.

# Troubleshooting

The following symptoms do not indicate malfunction.

Symptom	Cause
Mist emerges from indoor unit.	• Condensation effect due to cooling process.
Water flowing sound during operation.	• Refrigerant flow inside the unit.
The room has a peculiar odour.	• This may be due to damp smell emitted by the wall, carpet, furniture or clothing.
Indoor fan stops occasionally during automatic fan speed setting.	• This helps to remove the surrounding odour.
Airflow continues even after operation has stopped.	• Extraction of remaining heat from the indoor unit (maximum 30 seconds).
Operation is delayed a few minutes after restarting.	• The delay is a protection to the unit's compressor.
Outdoor unit emits water/steam.	• Condensation or evaporation occurs on pipes.
TIMER indicator is always on.	• The timer setting repeats daily once set.
POWER indicator blinks during HEAT mode with no warm air supply (and flap is closed).	• The unit is in defrost mode (and AIR SWING is set to AUTO).
Indoor fan stops occasionally during heating operation.	• To avoid unintended cooling effect.
POWER indicator blinks before the unit is switched on.	• This is a preliminary step in preparation for the operation when the ON timer has been set. When ON Timer is set, the unit may start earlier (up to 35 minutes) before the actual set time in order to achieve the desired temperature on time.
Cracking sound during operation.	• Changes of temperature caused the expansion/contraction of the unit.
Dusts accumulated on the wall.	• Due to air circulation or static electricity generated by the air conditioner. Some types of wall paper may collect dusts easily (recommended to clean the area around the air conditioner frequently).
During COOL/DRY mode, the indoor unit stops and POWER indicator blinks.	• The system has locked to operate in HEAT model only.
Discoloration of some plastic parts.	• Discoloration is subject to material types used in plastic parts, accelerated when exposed to heat, sun light, UV light or environmental factor.
Cooling/heating capacity reduced during the lowest fan speed setting.	• The low fan speed is low noise priority operation, so cooling/heating capacity may be reduced (depending on the condition). Increase the Fan Speed to increase the capacity.

Check the following before calling for servicing.

Symptom	Check
Operation in HEAT/COOL mode is not working efficiently.	<ul style="list-style-type: none"> <li>• Set the temperature correctly.</li> <li>• Close all doors and windows.</li> <li>• Clean or replace the filters.</li> <li>• Clear any obstruction at the air inlet and air outlet vents.</li> </ul>
Noisy during operation.	<ul style="list-style-type: none"> <li>• Check if the unit has been installed at an incline.</li> <li>• Close the front panel properly.</li> </ul>
Remote control does not work. (Display is dim or transmission signal is weak.)	<ul style="list-style-type: none"> <li>• Insert the batteries correctly.</li> <li>• Replace weak batteries.</li> </ul>
The unit does not work.	<ul style="list-style-type: none"> <li>• Check if the circuit breaker is tripped.</li> <li>• Check if timers have been set.</li> </ul>
The unit does not receive the signal from the remote control.	<ul style="list-style-type: none"> <li>• Make sure the receiver is not obstructed.</li> <li>• Certain fluorescent lights may interfere with signal transmitter. Please consult authorised dealer.</li> </ul>

# Troubleshooting

## When...

### ■The remote control is missing or a malfunction has occurred

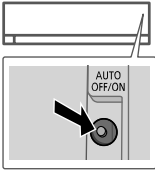

- 1.Raise the front panel.
- 2.Press the button once to use in AUTO mode.
- 3.Press and hold the button until you hear 1 beep, then release to use in forced COOL mode.
- 4.Repeat step 3. Press and hold the button until you hear 2 beeps, then release to use in forced HEAT mode.
- 5.Press the button again to turn off.

### ■The indicators are too bright

- To dim or restore the unit's indicator brightness, press  and hold for 5 seconds.

### ■Conducting a seasonal inspection after extended non-use

- Check the remote control batteries.
- Check that there is no obstruction around the air inlet and outlet vents.
- Use Auto OFF/ON button to select COOL/HEAT operation. After 15 minutes of operation, it is normal to have the following temperature difference between the air inlet and outlet vents:

COOL:  $\geq 8^{\circ}\text{C} / 14.4^{\circ}\text{F}$     HEAT:  $\geq 14^{\circ}\text{C} / 25.2^{\circ}\text{F}$

### ■The units are not going to be used for a long period of time

- Activate HEAT mode for 2~3 hours to remove moisture left in the internal parts thoroughly to prevent mould growth.
- Turn off the power supply and unplug.
- Remove the remote control batteries.

#### NON SERVICEABLE CRITERIAS

TURN OFF THE POWER SUPPLY AND UNPLUG then please consult an authorised dealer when in following conditions:

- Abnormal noise during operation.
- Water/foreign particles have entered the remote control.
- Water leaks from Indoor unit.
- Circuit breaker switches off frequently.
- Power cord becomes unnaturally warm.
- Switches or buttons are not functioning properly.

# Troubleshooting

## How to retrieve error codes

If the unit stops and the TIMER indicator blinks, use the remote control to retrieve the error code.

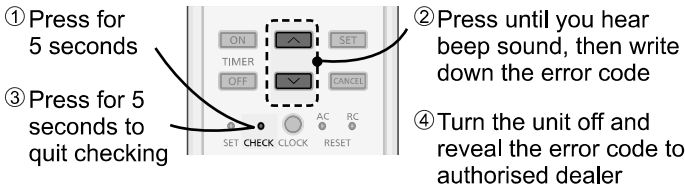

• For certain errors, you may restart the unit for limited operation if there are 4 beeps when operation starts.

Diagnostic display	Abnormality/Protection control
H 00	No memory of failure
H 11	Indoor/outdoor abnormal communication
H 12	Indoor unit capacity unmatched
H 14	Indoor intake air temperature sensor abnormality
H 15	Outdoor compressor temperature sensor abnormality
H 16	Outdoor current transformer (CT) abnormality
H 19	Indoor fan motor mechanism lock
H 21	Indoor float switch operation abnormality
H 23	Indoor heat exchanger temperature sensor 1 abnormality
H 24	Indoor heat exchanger temperature sensor 2 abnormality
H 25	Indoor ion device abnormality
H 27	Outdoor air temperature sensor abnormality
H 28	Outdoor heat exchanger temperature sensor abnormality
H 30	Outdoor discharge pipe temperature sensor abnormality
H 32	Outdoor heat exchanger temperature sensor 2 abnormality
H 33	Indoor/outdoor misconnection abnormality
H 34	Outdoor heat sink temperature sensor abnormality
H 35	Indoor/outdoor water adverse current abnormality
H 36	Outdoor gas pipe temperature sensor abnormality

Diagnostic display	Abnormality/Protection control
H 37	Outdoor liquid pipe temperature sensor abnormality
H 38	Indoor/outdoor mismatch (brand code)
H 39	Abnormal indoor operating unit or standby units
H 41	Abnormal wiring or piping connection
H 59	Eco sensor abnormality
H 64	Outdoor high pressure sensor abnormality
H 67	nanoe abnormality
H 70	Light sensor abnormality
H 97	Outdoor fan motor mechanism lock
H 98	Indoor high pressure protection
H 99	Indoor operating unit freeze protection
F 11	4-way valve switching abnormality
F 17	Indoor standby units freezing abnormality
F 90	Power factor correction (PFC) circuit protection
F 91	Refrigeration cycle abnormality
F 93	Outdoor compressor abnormal revolution
F 94	Compressor discharge pressure overshoot protection
F 95	Outdoor cooling high pressure protection
F 96	Power transistor module overheating protection
F 97	Compressor overheating protection
F 98	Total running current protection
F 99	Outdoor direct current (DC) peak detection

**Panasonic Corporation**  
1006 Kadoma, Kadoma City,  
Osaka, Japan  
Website: <http://www.panasonic.com>

© Panasonic Corporation 2016

Printed in Malaysia

Authorised representative in EU Panasonic Testing Centre Panasonic Marketing Europe GmbH Winsbergring 15, 22525 Hamburg, Germany
---

**ACXF55-04100**  
PC1016-0